

sofaforma

ASSEMBLY INSTRUCTIONS

DINING CHAIR MODEL#: KHARI

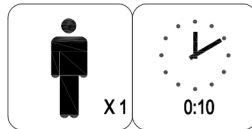
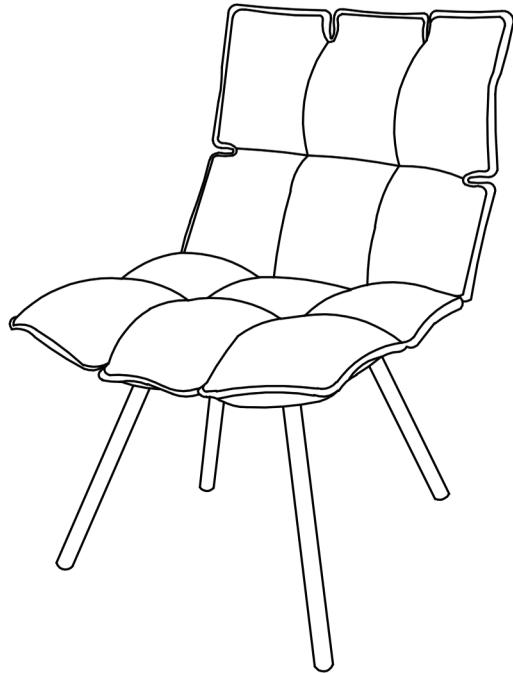
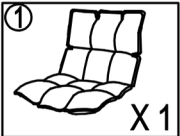
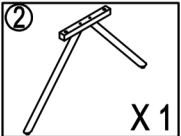
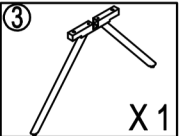
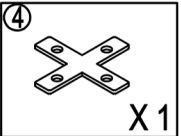
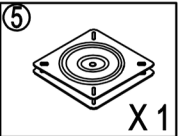
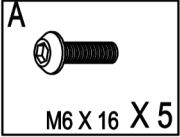
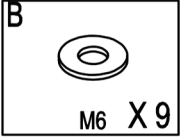
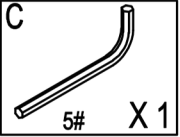
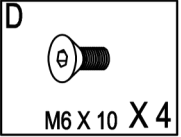
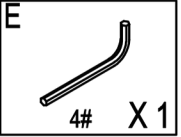
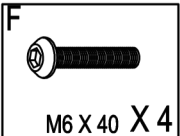

 X 1	 X 1	 X 1	 X 1	 X 1
A  M6 X 16 X 5	B  M6 X 9	C  5# X 1	D  M6 X 10 X 4	E  4# X 1
F  M6 X 40 X 4				

1

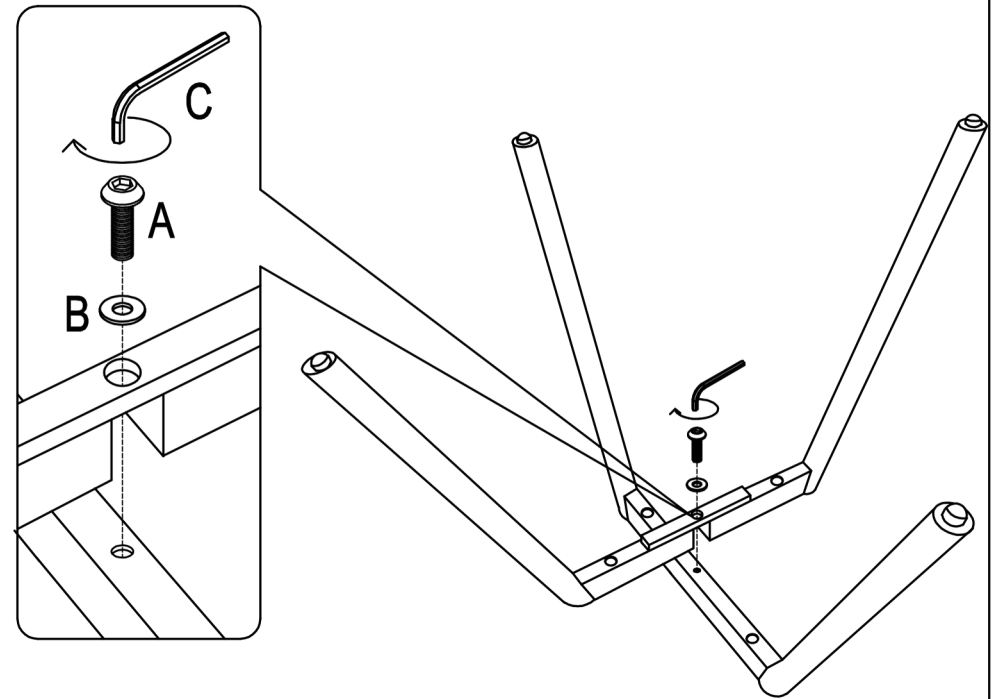

2

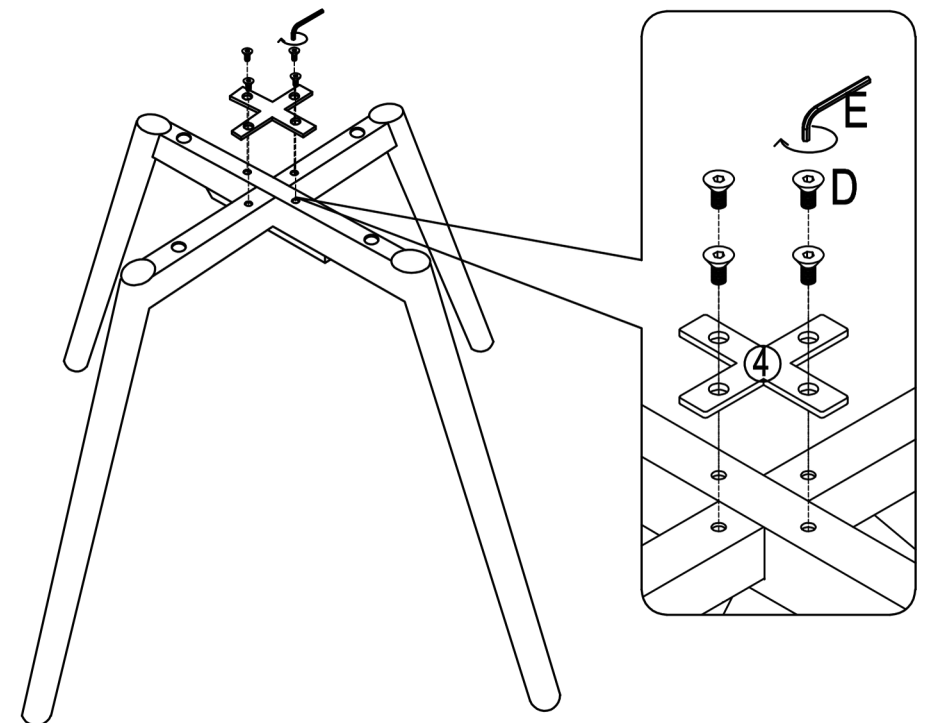

3

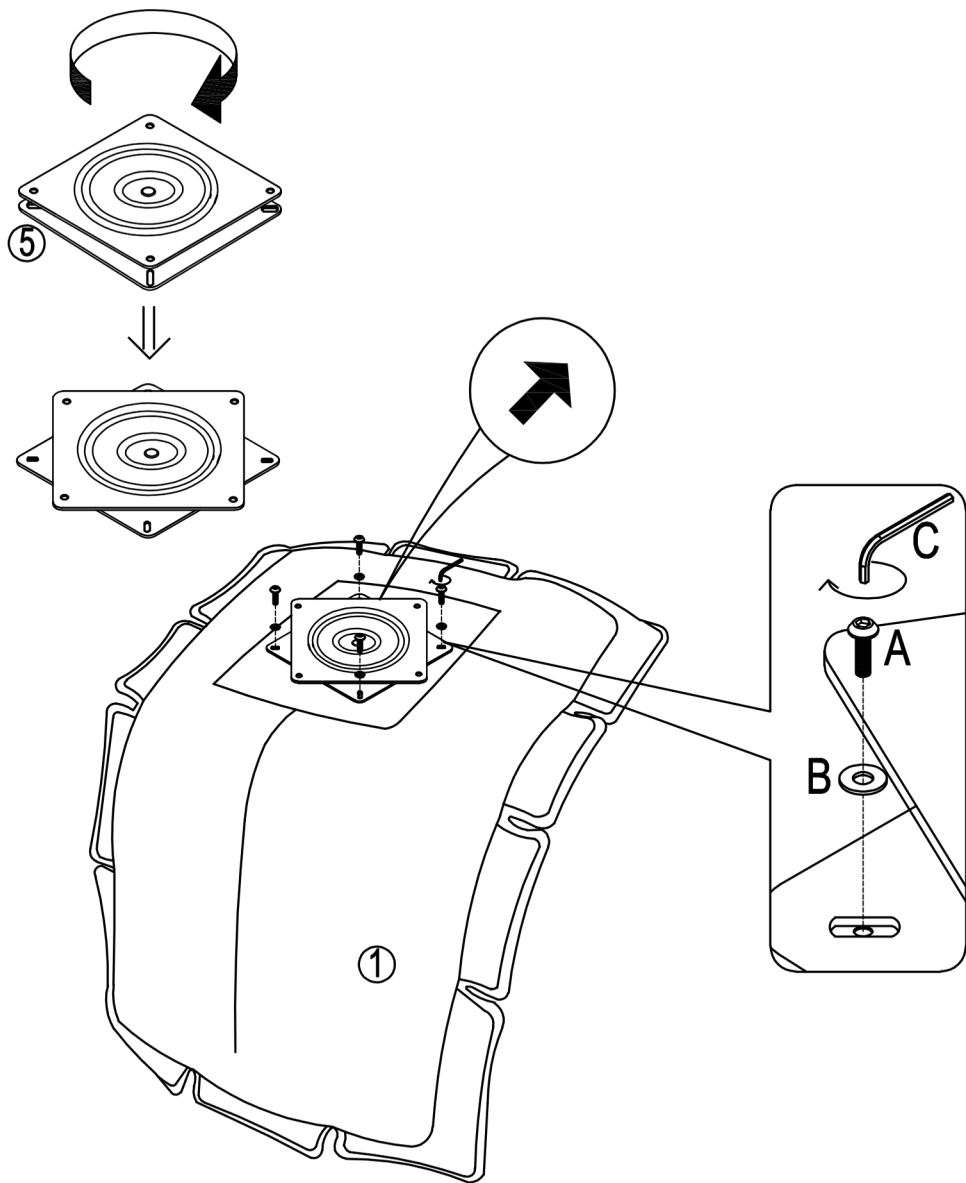

4

